

**SANY**

Quality Changes the World

# HIGH-TECH SOLUTIONS REDEFINED

PERFECTION AS A FOUNDATION.  
EFFICIENCY AS A BENCHMARK.

CONSTRUCTION MACHINERY



## CRAWLER EXCAVATOR **SY265C**

Engine  
**CUMMINS QSB6.7**  
Rated power  
**142 kW / 2000 U/min**  
Bucket capacity  
**1.3 m<sup>3</sup>**  
Operating mass  
**27 000 kg**

# SANY

## For challenging tasks, you need a first-class partner

Quality comes from experience. And from new ideas. This is why we combine these two crucial factors at SANY. This is because we are one of the world's leading producers, having sold more than **320 000** excavators in **10 years**. This means that you can always rely on sophisticated products that have been tried and tested in practice. An impressive **5–7%** of our annual turnover is dedicated to research and development. This is why we give you not only our word, but also our extraordinary **five-year warranty** as a guarantee of how powerful and robust our products are.

**320 000**  
EXCAVATORS SOLD IN  
**10 YEARS**

**5–7%**  
TURNOVER FOR RESEARCH  
AND DEVELOPMENT

**FIVE-YEAR  
WARRANTY\***

Quality Changes the World

\* Applicable in certain markets, please check with your local dealer.

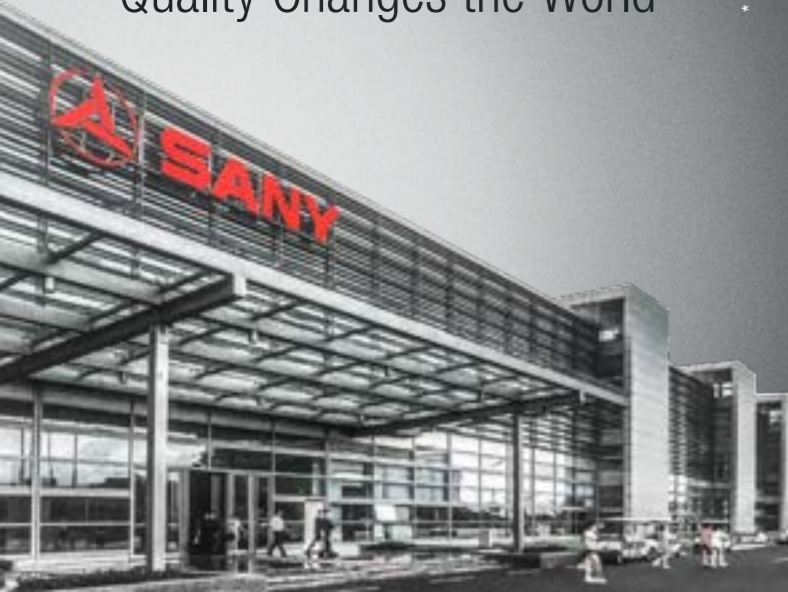

**SY265C**

### SY265C HARD FACTS

Max. bucket digging force  
187 kN (ISO)

Max. arm digging force  
130 kN (ISO)

Swingspeed  
10.6 U/min

Max. travel speed  
5.5 km/h

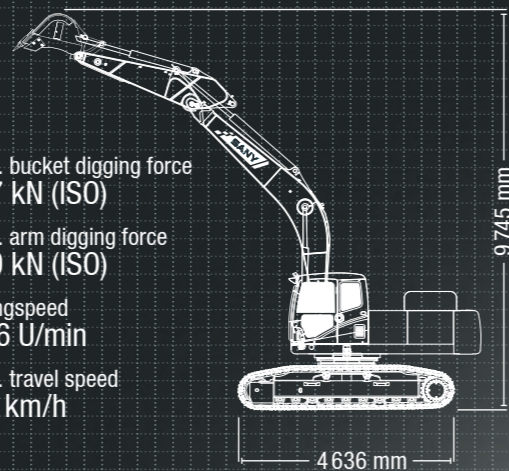

## AN ALLROUNDER WITH IMPRESSIVE POWER

With the SY265C crawler excavator, we have added a new dimension to the term „flexibility“. Straight from the factory, it is already equipped in such a versatile way that it is ideal for carrying out a wide range of tasks with the relevant attachment devices on all construction sites, whether in road construction, materials handling or demolition work. No matter how the

SY265C is used, its stability and power ensure that the required operational movements are performed quickly and safely. Its drive and hydraulics leave nothing to be desired and combine power, reliability and precision for impressive productivity. Just as you would expect from an excavator within this category.

## TOP PROPERTIES

ECONOMY

# SETS NEW STANDARDS FOR PRODUCTIVITY

Power is not enough on its own. To ensure that work is economical, you must be able to use power where it is needed in a targeted way. For the SANY SY265C, this ability is ensured by the fact that it is easy and precise to operate and has maximum stability. In addition, its hydraulic system has a sophisticated structure, which ensures that power is transferred efficiently for all work.

**SY265C**



### QUALITY

**Robust and durable** – in tough construction site conditions, the SY265C is in its element. Its undercarriage and solid boom provide an exemplary level of stability, even when working at full power. The seams are welded with high precision and ensure that the excavator has a long service life.

### DIMENSIONS

**Agile power** – the SY265C works through its programme quickly and with great power. This excavator has great power reserves in its 27 tonnes. The machine is mounted on a stable HD undercarriage so that it can be used to the full.

### USER EXPERIENCE

**Extremely comfortable** – from the clearly arranged fittings to the comfortable seat and the ergonomically designed controls, drivers can look forward to maximum comfort.

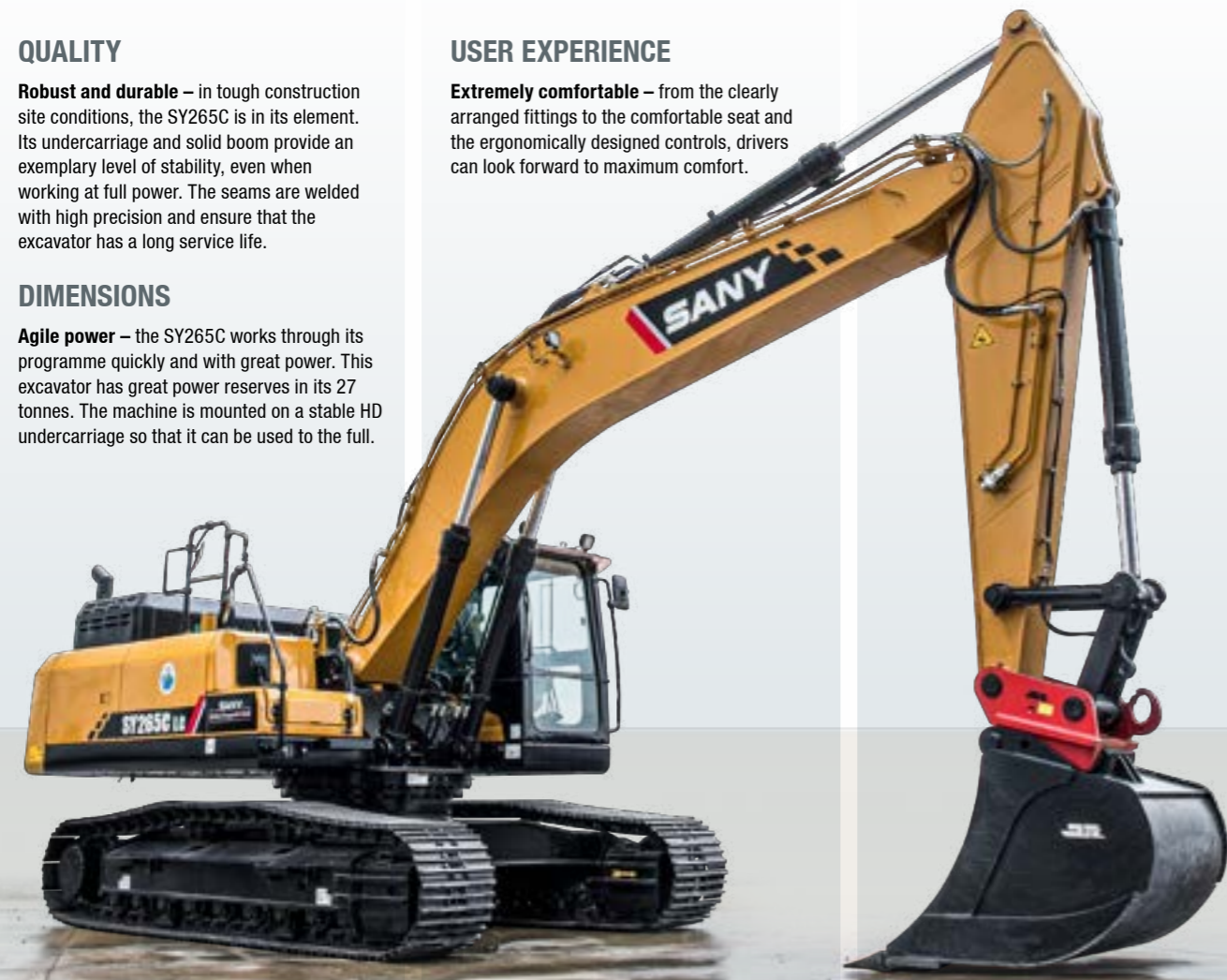

SAFETY

### Protection for people and machines

With the SY265C, safety begins before the excavator has even started up. To ensure that people, machines, tools and constructions are protected as optimally as possible, the standard equipment includes a safe route up to the cab, as well as handrails and anti-slip tread surfaces on the platform. This means that you are always on the safe side, including when carrying out maintenance work.

The standard package also includes the rear and side cameras, which offer a high level of safety for the driver, the machine and the environment. The package is completed by safety valves, which also come as standard.



### Absolute reliability – for peace of mind!

SANY's five-year warranty\* gives you the assurance that you can fully count on your equipment.

\* With participating partners

### SAFETY

**Safety first** – The standard safety package includes safety valves and cameras for monitoring the rear and side work areas. The cameras help the driver to move the machine safely and efficiently, even if it is not possible to have an overview of the situation.

### COMPONENTS

**Pure power** – the tried-&-tested Cummins engine unit and the reliable Kawasaki hydraulic system guarantee high performance, particularly when full power is required.

### ECONOMY

**Where efficiency meets power** – the efficient management of the engine and hydraulic system makes sure that all of the components interact optimally. This minimises consumption and lowers costs every time the excavator is used.



ECONOMY

### Where cost-effectiveness meets power

The SANY SY265C is multifaceted when it comes to cost-effectiveness. This includes its sensationally low fuel and AdBlue consumption. The precise interplay between low engine speeds and hydraulic power which is optimally set to requirements provides the best fuel efficiency for every application.

The entire machine can also be precisely adapted to the requirements of each task by using the selectable operating modes. This means that you can achieve the optimum cost-effectiveness for your machine virtually at the touch of a button. Together with the sophisticated maintenance concept, this is the key to impressively low operating costs.

USER EXPERIENCE

# COMFORT THAT TOUGH GUYS APPRECIATE

The driver's cab has an impressive number of added benefits related to comfort. It is extensively insulated and minimises noise, vibrations and dust.

The driver's most important items can be kept in two storage compartments behind the seat; one of which is chilled. The air suspension driver's seat with a high seat backrest and individual adjustment options protects the driver's back during a long working day and prevents them from becoming fatigued. The heated seat supplied as standard is a pleasant feature on cold days.

The panoramic view provides a clear outlook for the working day ahead. The large front, side and rear windows give drivers optimum visibility in all directions. An automatic climate control system, a radio with a USB port and 12 V sockets are also supplied on board as standard.



USER EXPERIENCE

## There is no more sensitive way to control power

Working precisely is the key to greater cost-effectiveness and satisfied customers. The ergonomic joystick levers apply the required movements in a particularly sensitive way, immediately and with pinpoint accuracy.



USER EXPERIENCE

## For an even better overview

Modern 10" touchscreen display for simple, intuitive operation. The most important information is always available at a glance and the touchscreen offers fast, direct access to all the menus.



### Our highlights – the added benefits SANY offers you:

- + 10" high-resolution touchscreen display
- + Stage V emission standard
- + 2 cameras as standard
- + Fast, powerful hydraulics
- + Heavy-duty undercarriage
- + Comfortable driver's cab



QUALITY

## Good reasons to be into heavy metal

The machines have a great deal of work to do during their tough day-to-day work on construction sites. This is why – from the design stage, to selecting the materials used, machining and conducting the final checks – all excavators by SANY are designed to be robust. For instance, all of the welded seams

are computer-controlled by robots. This ensures stability and reliability. In addition, the robust, wide heavy-duty undercarriage provides a high level of stability. This allows the SY265C to optimally apply its power. Also good to know: All of the access panels are only made from metal.

DIMENSIONS

# ALWAYS STAY STEADY

Combined with the SY265C's high mass, its particularly stable heavy-duty undercarriage provides the greatest possible stability. Its integrated reinforcements and the use of robust, high-strength steel ensure minimal wear, even when used continually under the maximum load. The steel chains used also offer the best quality standard – for secure stability on any surface.

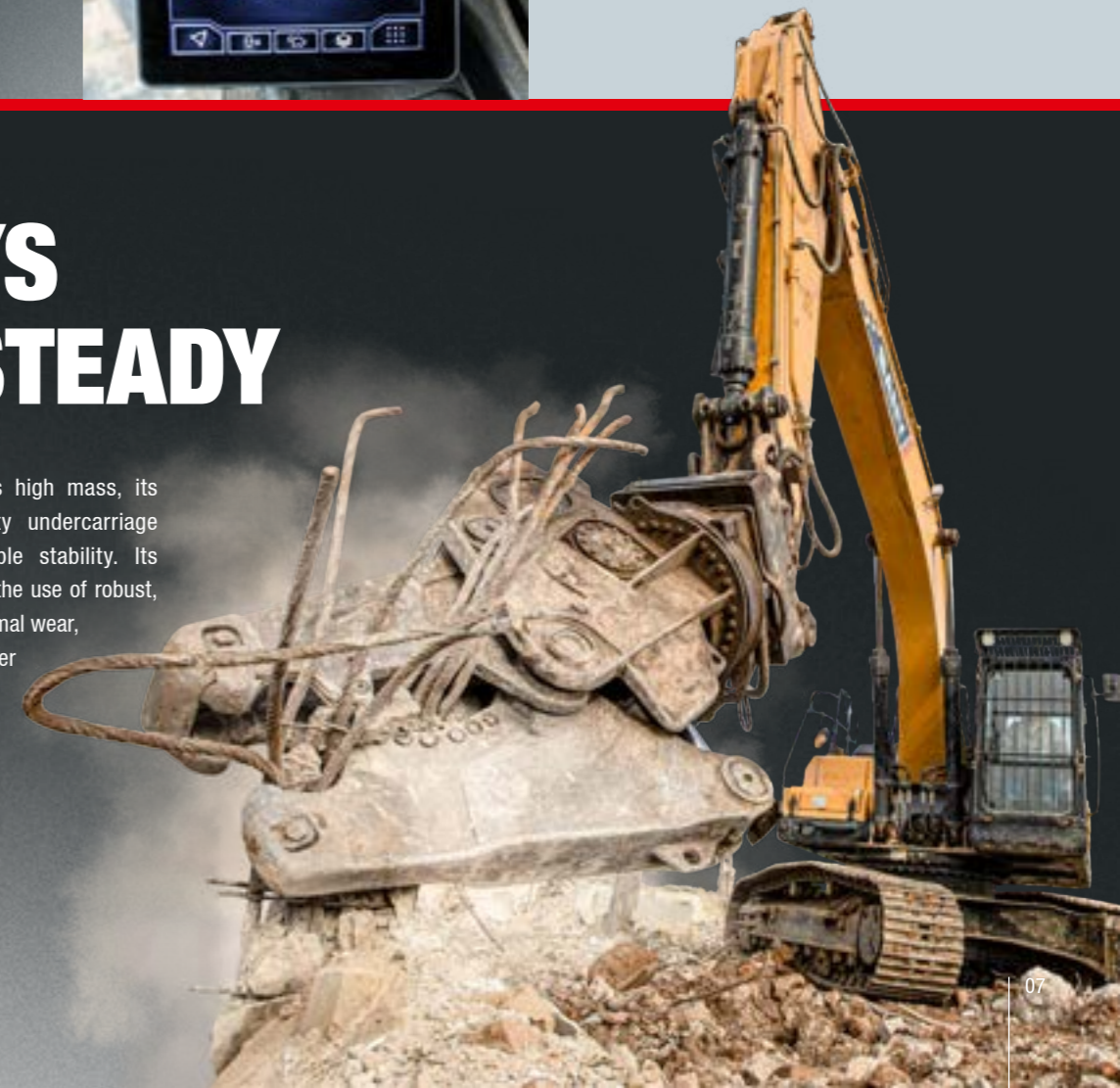

## ENGINE

Model	CUMMINS QSB6.7
Typ	Water-cooled, 6 cylinder, with commonrail and Adblue
Exhaust emissions	Stage V
Rated power	142 kW / 2 000 rpm
Max. torque	809 Nm / 1 500 rpm
Displacement	6 700 ccm
Batteries	2 × 12 V / 120 Ah

## HYDRAULIC SYSTEM

Main pump	2 x variable piston pump with electronic positive control
Max. oilflow	2 x 260 l/min
Travel motor	Variable displacement axial piston motor
Swing motor	Axial-piston motor
Max. oilflow (AUX1)	400 l/min

## RELIEF VALVE SETTINGS

Implement circuit	343 bar
Power boost	373 bar
Swing circuit	290 bar
Travel circuit	343 bar
Pilot pressure	39 bar

## SERVICE REFILL CAPACITIES

Fuel tank	465 l
Engine coolant	40 l
Engine oil	27 l
Drive (per side)	7.8 l
Adblue	38 l
Hydraulic oil tank	230 l

## PERFORMANCE

Swingspeed	10.6 rpm
Max. travel speed	High 5.5 km/h, slow 3.7 km/h
Max. travel force	227 kN
Gradeability	35°
Bucket capacity	1.3 m <sup>3</sup>
Ground pressure	0.53 kg/cm <sup>2</sup>
Bucket digging force ISO	187 kN
Arm digging force ISO	130 kN

## UNDER AND UPPER STRUCTURE

Boom length	5 900 mm
Arm length	2 950 mm
Bottom rollers	9
Top rollers	2
Rotation device	Planetary gear reducer driven by an axial piston motor, automatic hydraulic released slewing brake

## OPERATING MASS

SY265C	27 000 kg
--------	-----------



## DIMENSIONS (TRANSPORT)

A Transport length	10 290 mm
B Transport width	*2 990 mm
C Upperstructure carriage	2 990 mm
D Height over cabin/ROPS	3 140 mm
E Height of Boom – transport	3 225 mm
F Overall length of crawler	4 636 mm
G Tail length	3 105 mm
H Track gauge	*2 390 mm
I Track height	945 mm
J Track pads width	600 mm
	700 mm
	800 mm
K Min. ground clearance	470 mm
L Counterweight clearance	1 045 mm
M Engine cover height	2 640 mm
N Tail swing radius	3 105 mm
O Center distance of tumbler	3 833 mm

\*at 600 mm track pads width

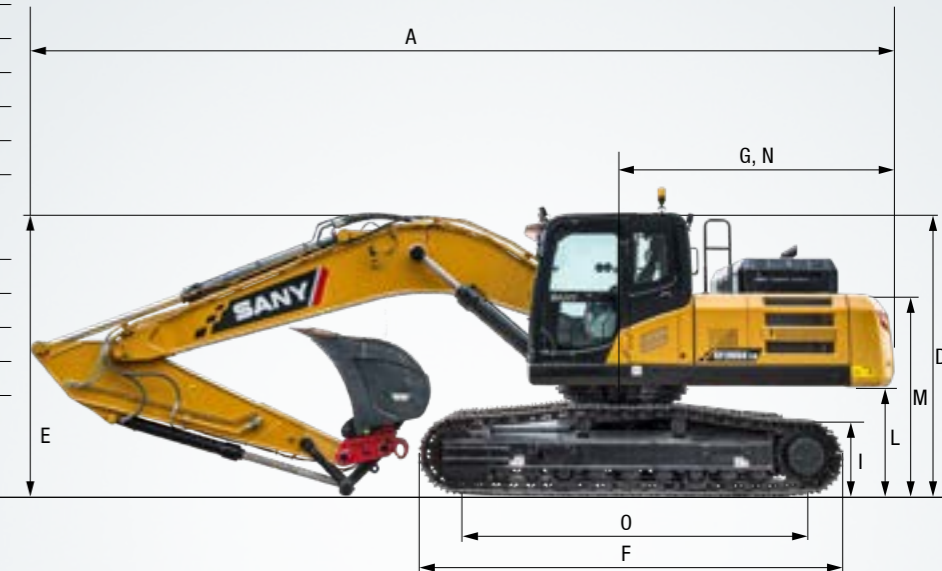

## LIFTING CAPACITIES\*

Load point height	Radius				Max. digging reach						
	3.0 m	4.5 m	6.0 m	7.5 m	Capacity		m				
4.5 m kg			7159	5911	6593	5515	5665	5010	8.10		
3.0 m kg		10683	9455	8242	5662	7093	5359	6121	4621	8.40	
1.5 m kg		12667	8774	9291	5333	7633	5195	5949	4429	8.50	
Ground kg		13607	8436	9984	5111	7959	5076	6114	4527	8.26	
-1.5 m kg	11229	11229	13575	8359	10131	5024	7920	5039	6703	4982	7.75
-3.0 m kg	17605	15221	12644	8459	9519	4875		7931	5867	6.91	
-4.5 m kg	14134	14134	10360	8757				8623	8065	5.51	

\*at 800 mm track pads width LC-Variant

## WORKING AREA

A Max. digging reach	10 225 mm
B Max. digging depth	6 705 mm
C Max. digging height	9 745 mm
D Max. dumping height	6 715 mm
E Min. dumping height	2 490 mm
F Max. vertical digging depth	5 675 mm
G Overall height over arm by min. swing radius	8 020 mm
H Min. swing radius	3 800 mm

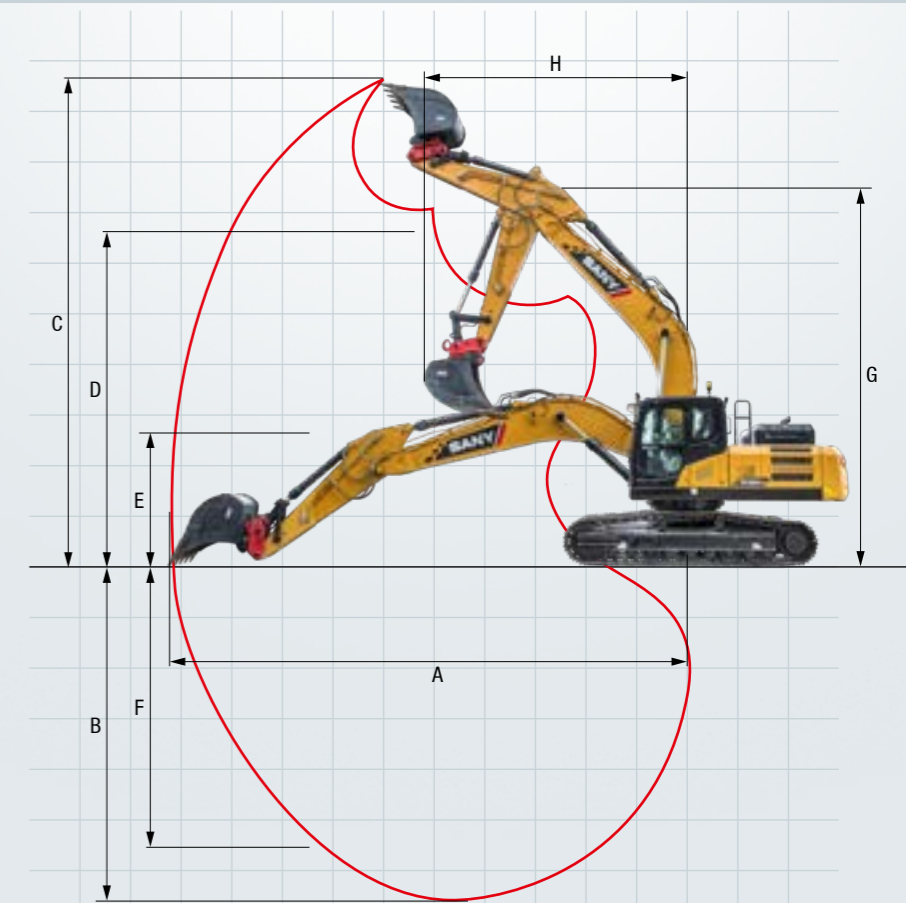

### The all-inclusive excavator

Thanks to its extensive range of equipment, the SY265C perfectly meets the ever-growing demands for an efficient crawler excavator in the medium category. It offers a comfortable and productive workstation, with unique performance and excellent extra features included as standard.



#### OPERATORS COMFORT / CABINE

Heater	●
Automatic air conditioning C/H*	●
Radio and speaker	●
Armrests (adjustable)	●
Airsuspension seat	●
Heated seat	●
Wiper	●
Sprayer f. wiper	●
AUX 1 on Joystick	●
AUX 2 on Joystick	●
Removable front-window	●
Sky light openable	●
10" touchscreen display	●

#### WORKING EQUIPMENT

Boom and arm load holding valves with overload indicator	●
Double acting circuit for hydraulic quick coupler with piping	●
Breaker&Shear line proportional on Joystick with piping	●
Rotation line proportional on Joystick with piping	●
Rotation line on Joystick with piping	●
Flow adjustment for attachments	●

#### UNDERCARRIAGE

Steel tracks 600	●
Holes/loops for fixing	●

Standard equipment ● Special option ●

The standard and special options differ depending on the country in which the crawler excavator is delivered. If you have any questions, please contact your dealer directly.  
\* The air conditioner contains fluorinated greenhouse gases: Refrigerant type: HFC-134a, Global warming potential: 1 430, Quantity: 0,9 kg, CO<sub>2</sub>e: 1,29 t

#### WORKING LIGHTS

Lights – front (LED)	●
Lights – boom (LED)	●
Lights – platform (LED)	●
Lights – back (LED)	●

#### ENGINE

Auto idle	●
Diesel filter	●
DOC	●

#### HYDRAULIC SYSTEM

Swing brake	●
2 speed travel	●
Piping for additional hydraulic function AUX 1	●
Piping for additional hydraulic function AUX 2	●
Hydr. Pre-pressure operating joysticks	●
Mainfilter	●

#### SAFETY

Battery master switch	●
Travel Alarm	●
Warning beacon	●
Camera	●
Handrails	●
Lockable hoods	●
Lockable fuel cap	●

## A SERVICE YOU CAN RELY ON

Just as we do with our excavators, we also demand high quality and reliability of our service products. This underlines our equipment's performance in terms of their durability and their excellent price-performance ratio. After all, maintenance is crucial

for efficiency, cost-effectiveness and safety. Your SANY dealer is happy to help you with a comprehensive range of services to ensure that your machine continues operating efficiently in the long term.

### SANY – flexible, fast and always there for you

Rapid assistance, tailored advice and a reliable supply of original parts – that is what we mean by a premium service.



#### The added benefits SANY offers you:

- ✦ Fast supply thanks to the central warehouse near Cologne
- ✦ More than 15,000 spare parts to make your machine highly reliable
- ✦ Expert knowledge for optimal supply for your machine
- ✦ Thanks to SANY's special training programme, our dealers are always kept up-to-date so that they can face all technical challenges.

### Parts supply – quick and reliable

With the purchase of a SANY crawler excavator you have made an investment in the future. Fast availability of spare parts is your guarantee of minimal downtimes and failure times.



### Detailed information in black and white

Handbooks and documents are available for all SANY crawler excavators, and these can help you with operation, maintenance, servicing and repairs. These include operating and maintenance instructions and technical specifications.



# COMPACT POWER FOR VERSATILE USE

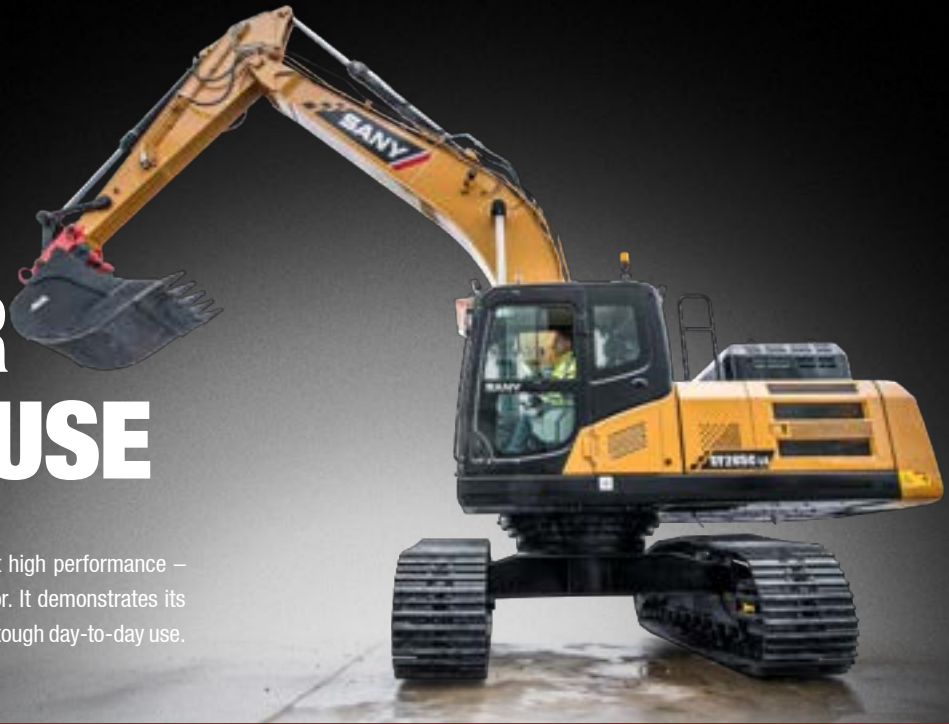

The SANY SY265C embodies reliable and fuel-efficient high performance – perfectly housed in a compact, robust crawler excavator. It demonstrates its impressive cost-effectiveness and great versatility in its tough day-to-day use.

## ROBUST AND DURABLE

The **robust design of the reinforced undercarriage** easily withstands vibrations and high workloads. The boom, with its one-piece design and **precise welded seams**, also stands out thanks to its **stability** and optimum load distribution.

## EXTREMELY COMFORTABLE

You always need to be fully focused when working on construction sites. From the air-suspension comfort seat to the automatic air conditioning system, from the spacious footwell to the **precise steering** via the **joystick and the clear 10" touchscreen display**, the **workstation** in the SY265C provides machine operators with the best conditions to achieve this.

## SAFETY FIRST

We have taken all possible measures to minimise the risk to drivers in the cab and to the machine environment. From the optimal panoramic view, which includes a **rear camera and side camera**, to the hand rails and **anti-slip tread surfaces**, we always play it safe.

## AGILE POWER

The stable **heavy-duty undercarriage** and the high mass provide the SY265C with the stability required to make **quick and powerful operational movements**. The excavator can therefore even tackle comprehensive tasks in a short time.

## PURE POWER

The powerful 6-cylinder Cummins QSB6.7 engine with **SCR** complies with the latest emissions requirements and, combined with renowned Kawasaki hydraulics, **offers reliably high performance**. The hydraulic pump is always operated in such a way that **precisely the oil quantity required** is made available. This results in outstandingly high efficiency at the lowest possible engine speed.

## WHERE EFFICIENCY MEETS POWER

In conjunction with the electronic fuel injection, the autothrottle function adjusts the engine speed to the power required. This means that the smart hydraulic system **reduces the fuel consumption, engine wear and exhaust emissions**.

## TECHNICAL HIGHLIGHTS

Engine	CUMMINS QSB6.7
Rated power	142 kW / 2 000 rpm
Max. torque	809 Nm / 1 500 rpm
Max. travel speed	5.5 km/h
Swingspeed	10.6 rpm
Mainpump	2 x variable-piston-pump with electronic positive control
Max. oilflow	2 x 260 l/min



**„THE MACHINE IS ECONOMICAL AND POWERFUL!“**

*Patrick Meyer – machine operator at MBT Recycling*

Not all products are available in all markets. As part of our continuous improvement process, we reserve the right to modify specifications and designs without giving prior notice. The figures may contain additional options.

# SANY

Quality Changes the World

## SANY EUROPE GmbH

Sany Allee 1  
D-50181 Bedburg  
fon +49 2272 90531 100  
fax +49 2272 90531 109  
info@sanyeurope.com  
www.sanyeurope.com